

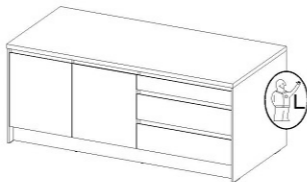

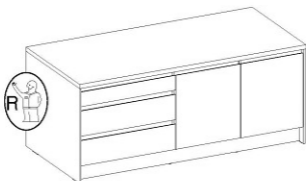

















210 / 90



 A	 B	 B2	 C	 C5	 D2	 D4	 E5	 E1		
34	22	10	10	6	12	2	2	22		
6.5x48x16	15x5mm	L-150mm	135/16mm	L-450mm	III		120/16mm	 L	 L19	 M2
4	2	2	2	3		2	12	12	2	12
16.3x28mm	 M8	 O	 O1	 P	 P5	 T15	 T10			
12	1	1	6	40	3	6				

ISM-KUH-01121

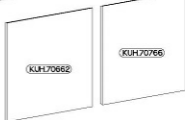
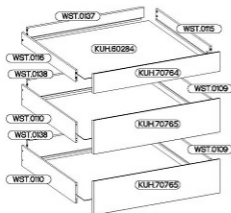
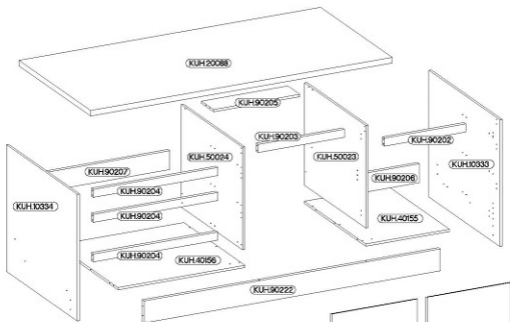

Colli	Ersatzteil Nummer	Dimension
Colli 2/8	KUH.10334	870x595x16
	KUH.60284 x3	449x821x2,5
	KUH.70662	596x678x16
	KUH.70764	879x134x16
	KUH.70765 x2	879x232x16
	KUH.70766	579x678x16
	WST.0137	811x80x12
	WST.0138 x2	811x140x12

Colli	Ersatzteil Nummer	Dimension
Colli 1/8	KUH.10333	870x595x16
	KUH.40155	583x512x16
	KUH.40156	883x512x16
	KUH.50023	704x512x16
	KUH.50024	704x512x16
	WST.0109 x2	450x140x12
	WST.0110 x2	450x140x12
	WST.0115	450x80x12
	WST.0116	450x80x12

Colli	Ersatzteil Nummer	Dimension
Colli 3/8	KUH.20088	2100x600x38
	KUH.90202	567x55x16
	KUH.90203	600x55x16
	KUH.90204 x3	867x55x16
	KUH.90205	600x100x16
	KUH.90206	567x130x16
	KUH.90207	867x130x16
	KUH.90222	2066x150x16

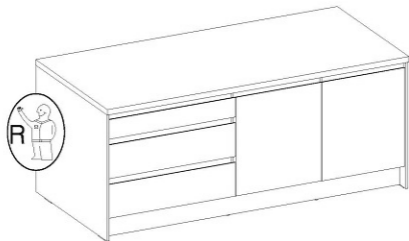

1 - 29

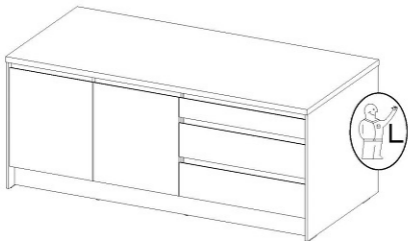

1 - 10

30 - 48

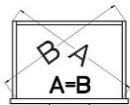
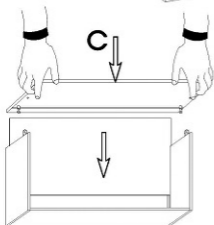
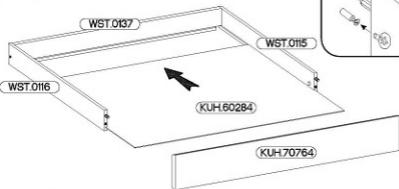

4

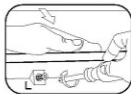
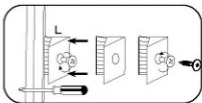
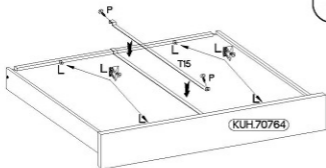
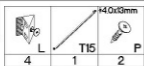

5



6

4	8	1
		
C5	A	O1

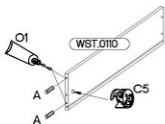

x2

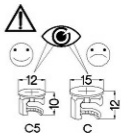
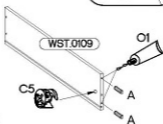

7

8

B2

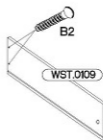
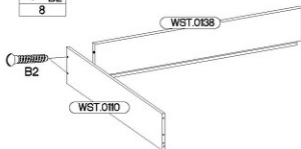

x2

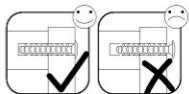

8

4

D2

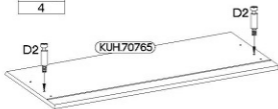

x2



9

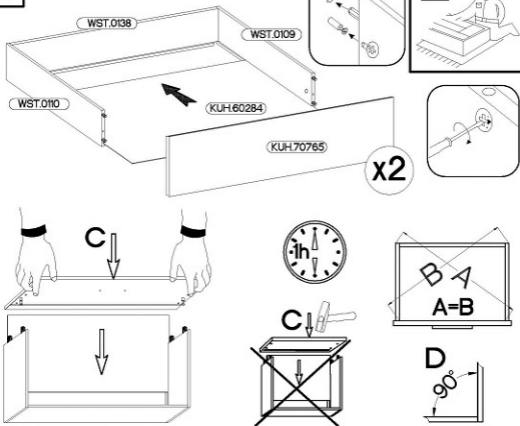

10

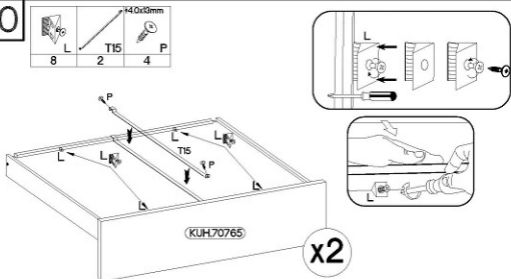

6.5x48x16	L	R	+6.3x13mm	+6.3x28mm	+20/16mm	L=20mm
F2	L-450mm	III	M2	M8	J44	D2
2	3		12	12	12	5

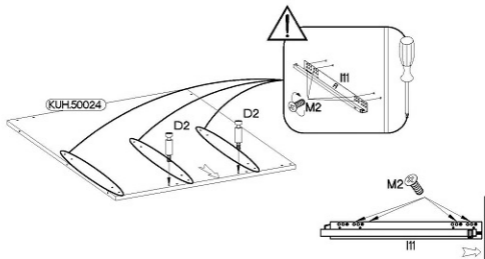
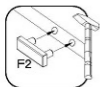
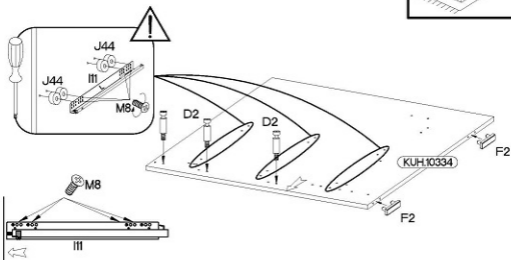

6.5x48x6	L=20mm	16x30mm	15/16mm
F2	D2	A	C
2	1	16	10

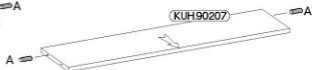
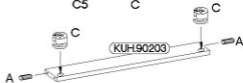
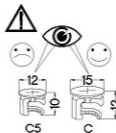
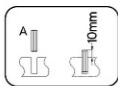
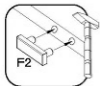
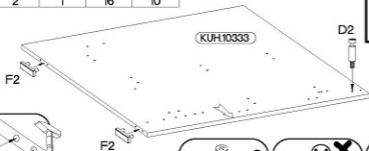





F15

∅15x5mm	∅8x30mm	L=150mm	∅3.5x13mm
F4	A	F15	P5
2	6	2	8

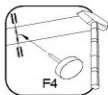
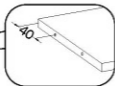
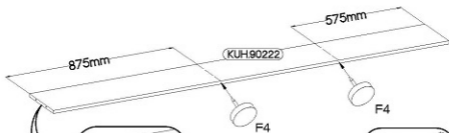
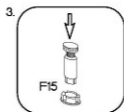
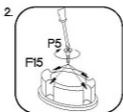
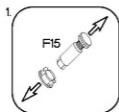
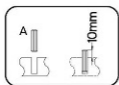
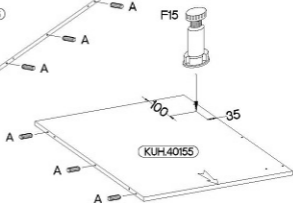
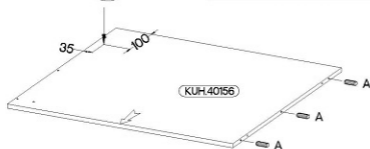

14

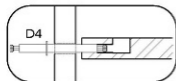
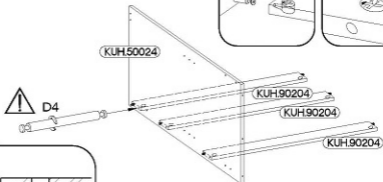
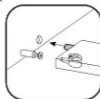
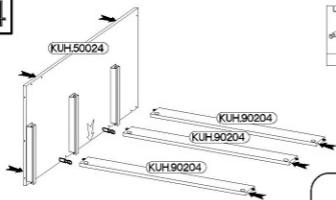

15

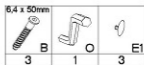
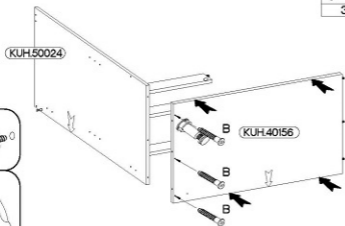

16

6,4 x 50mm

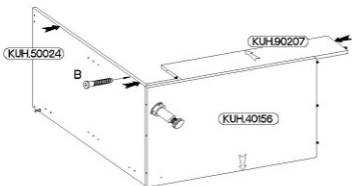
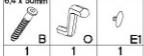

17

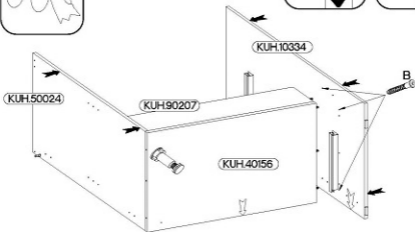
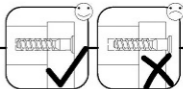

6,4 x 50mm



18

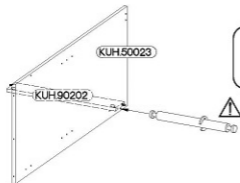
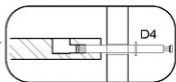
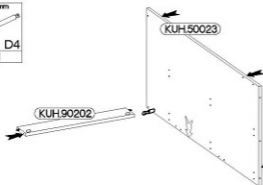

19

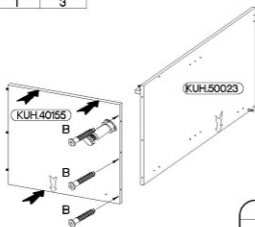

20

6,4 x 50mm

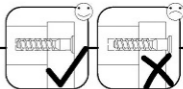
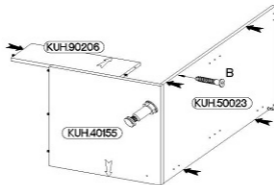
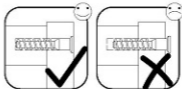

21

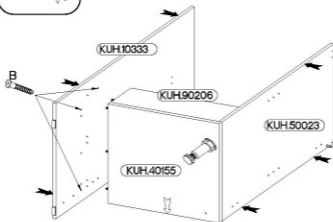

6,4 x 50mm

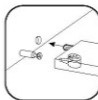
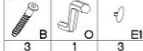

22

6,4 x 50mm

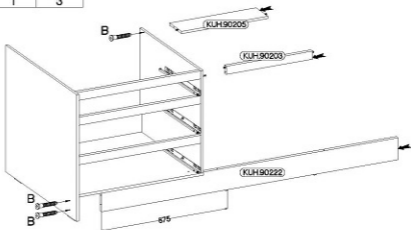
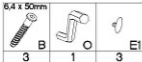

23

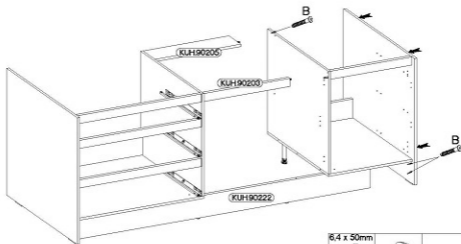
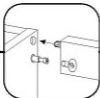

6,4 x 50mm

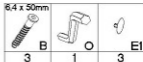

24

6,4 x 50mm



B

2



O

1



E1

2

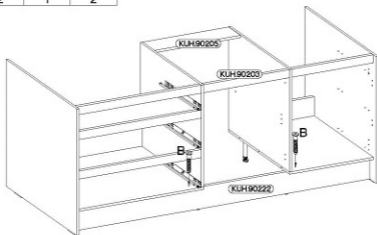

25

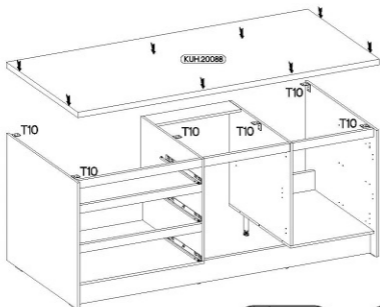

1.

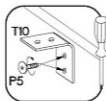

2.

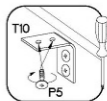

#3.5x13mm



P5

24





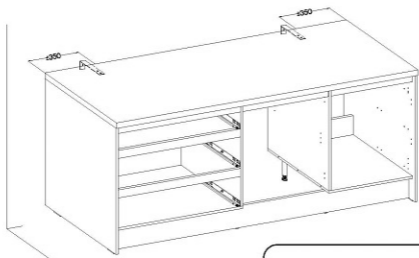

T10

6

43.5x13mm	
	
L19	P5
2	4

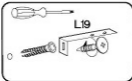

- 
- 
- 
- 
- 





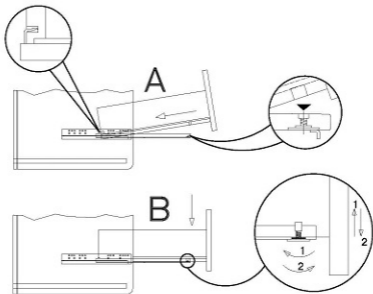
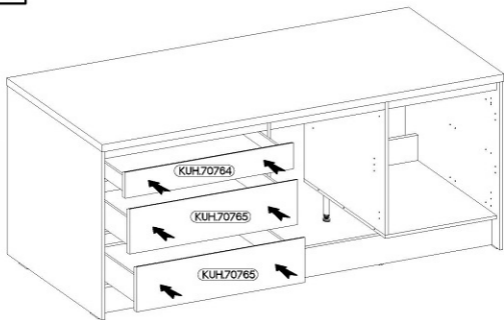

28

435/16mm	43.5x13mm	435mm	
			
HG2	P5	E5	J5
2	4	2	2

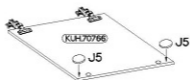
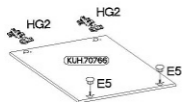
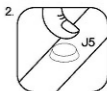
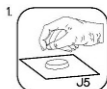

29

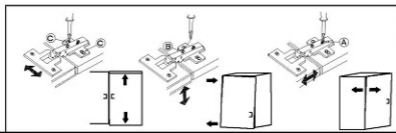
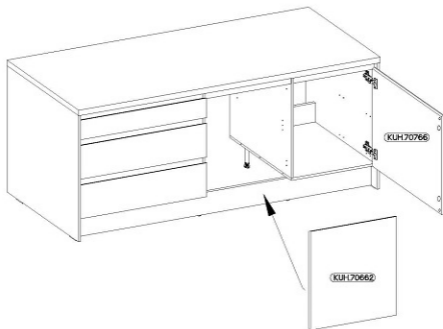

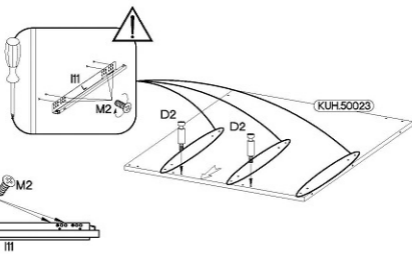
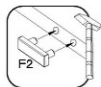
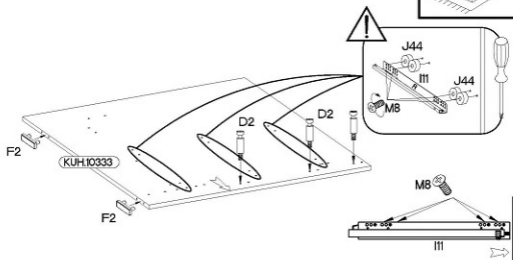

6.5x48x16	L	R	ø6.3x13mm	ø6.3x28mm	ø20/16mm	L=20mm
F2	L-450mm	III	M2	M8	J44	D2
2	3		12	12	12	5

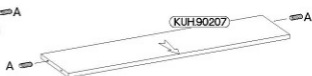
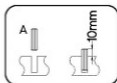
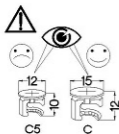
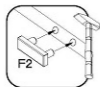
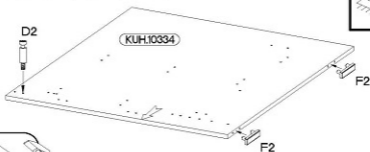

6.5x48x6	L-20mm	16x30mm	15/10mm
F2	D2	A	C
2	1	16	10



∅15x5mm	∅8x30mm	L=150mm	∅3.5x13mm
 F4	 A	 F15	 P5
2	6	2	8

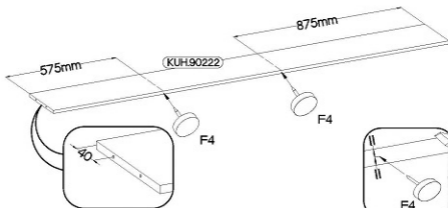
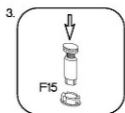
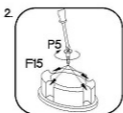
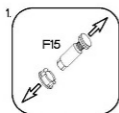
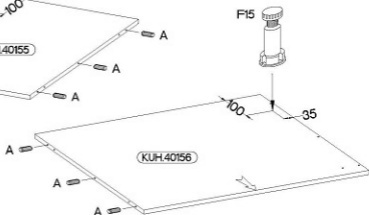
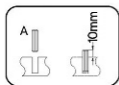

33

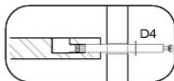
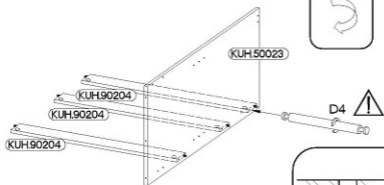
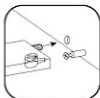
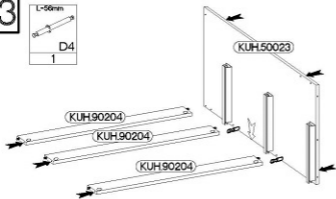

34

6,4 x 50mm

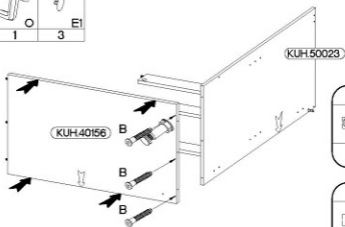

35

6,4 x 50mm

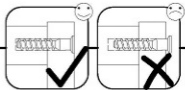
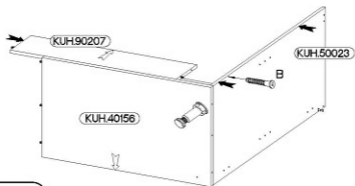

36

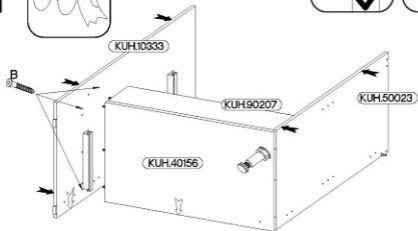

6,4 x 50mm

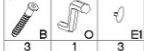

37

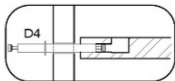
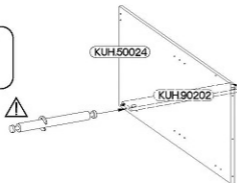
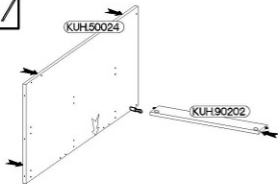

38

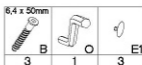
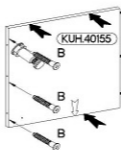



39

6,4 x 50mm

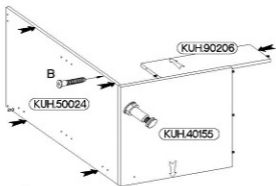
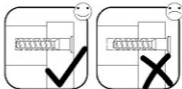
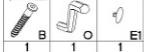

40

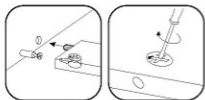
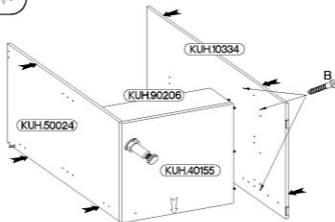
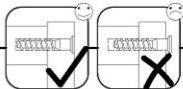

6,4 x 50mm

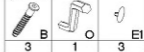

41

6,4 x 50mm

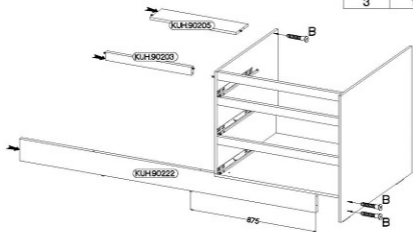
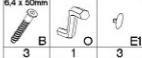

42

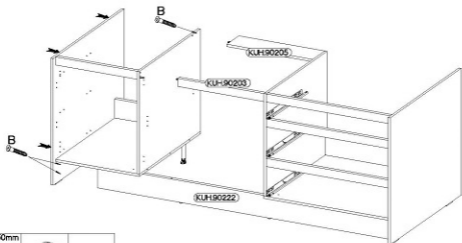
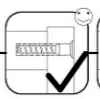
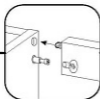

6,4 x 50mm



43

6,4 x 50mm



B



O



E1

2

1

2

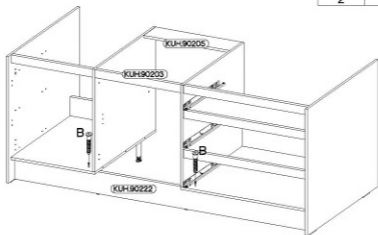

44

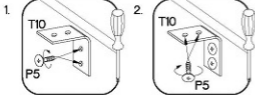
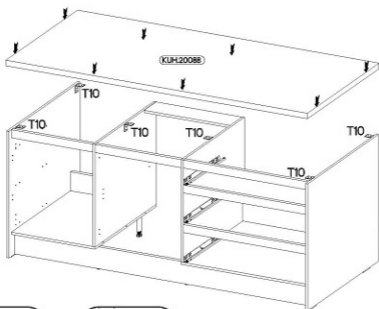

#3.5x13mm



P5

24





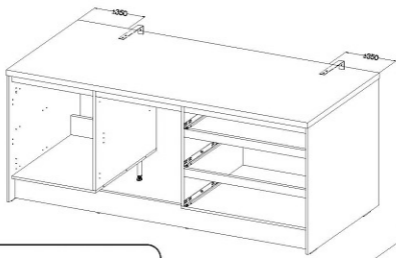

T10

6

43.5x13mm	
	
L19	P5
2	4

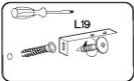

- 
- 
- 
- 
- 



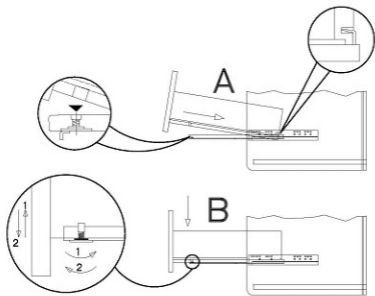
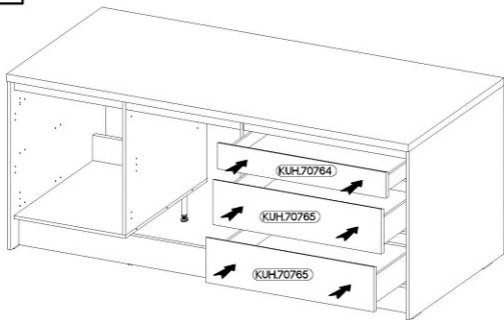

47

435/16mm 43.5x13mm	435mm	435mm	435mm
			
HG2	P5	E5	J5
2	4	2	2

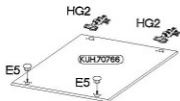
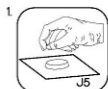

48

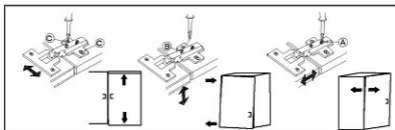
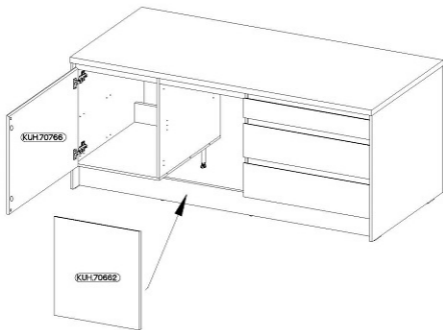

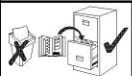
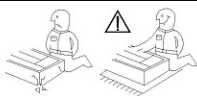
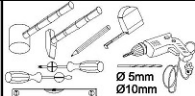
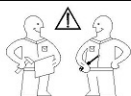

123 / 65

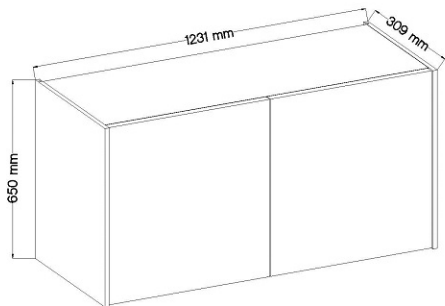

 A 12	 B 12	 E1 12	 HG2 4	 J3 8	
 K 3	 L2 3	 O 1	 P5 8	 P7 20-25	 P8 6



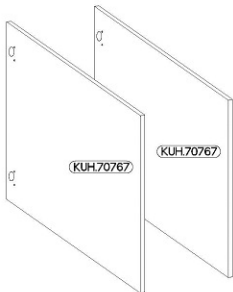
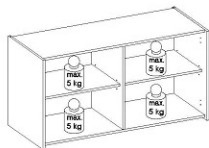
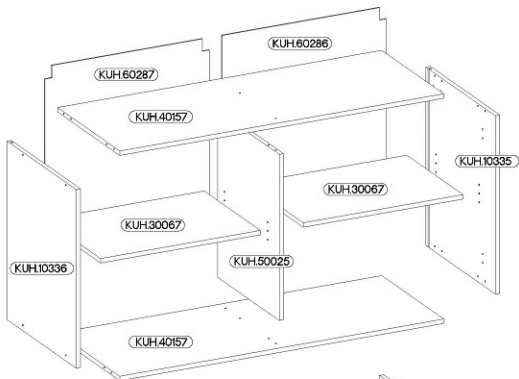

ISM-KUH-01120



Colli	Ersatzteil Nummer	Dimension
Colli 4/8	KUH.10335	650x309x16
	KUH.10336	650x309x16
	KUH.30067 X2	59x250x16
	KUH.40157 x2	1199x276x16
	KUH.50025	605x275x16
	KUH.60286	635x608x2,5
	KUH.60287	635x608x2,5
	KUH.70767 x2	646x596x16



		
#8x30mm	#4.0x30mm	
A	P8	K
12	6	3

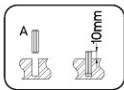
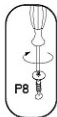
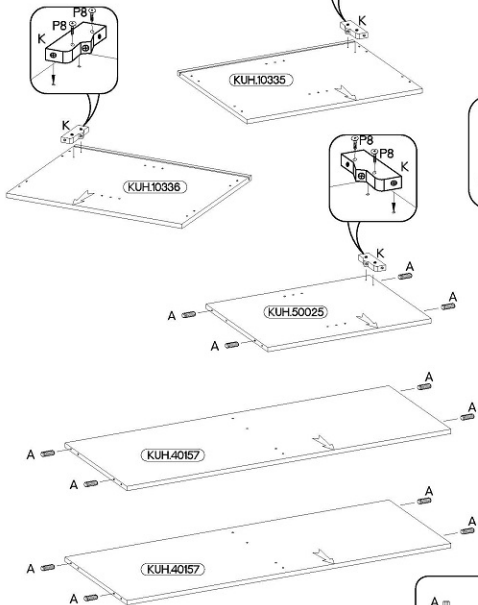

2

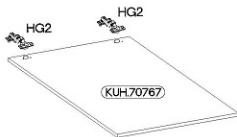
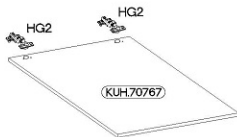
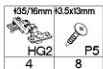

3

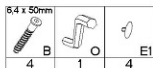
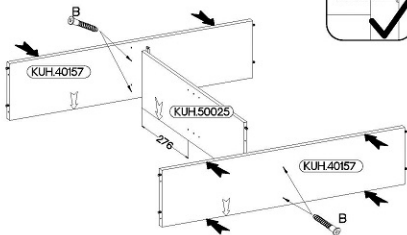

4

6,4 x 50mm

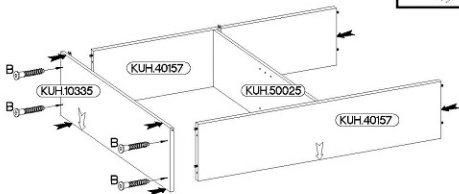
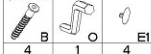

5

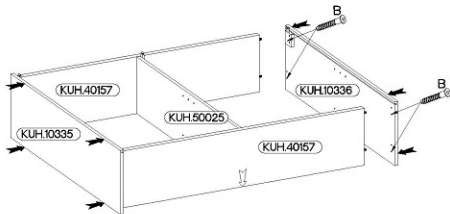
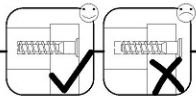

6,4 x 50mm

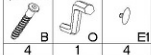

6

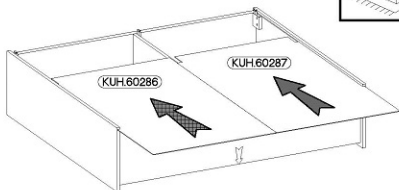

7

	$\varnothing 3.0 \times 20 \text{mm}$	
L2		P7
3		20-25

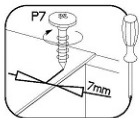
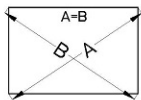
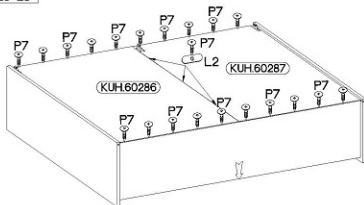

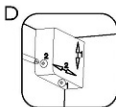
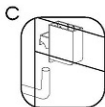
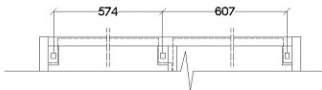
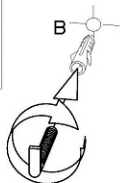
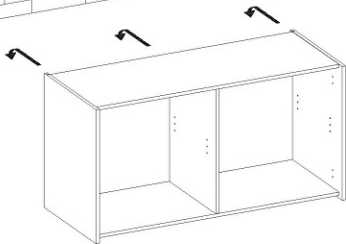
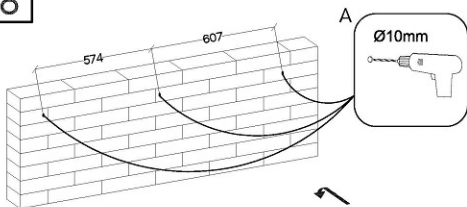

9

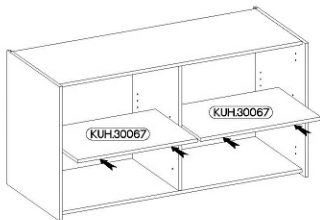

10

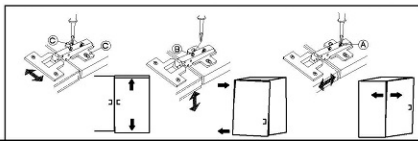
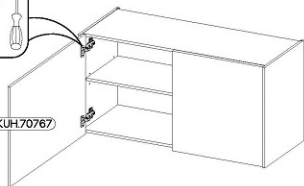
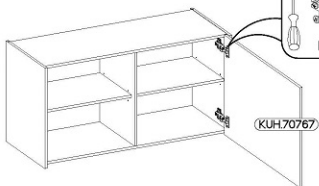

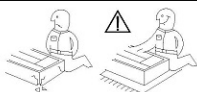
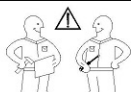





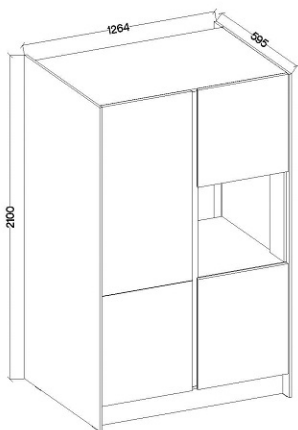













120 min

126 / 210



 A	 B	 C	 D2	 E	 E1	 F2	 F4	 F15	 HG2	 J3
52	26	16	16	16	26	4	1	1	9	12
 L25	 O	 P1	 P5	 P7	 R	 T3	 T4			
2	1	18	26	55-60	2	1	4			

ISM-KUH-0118

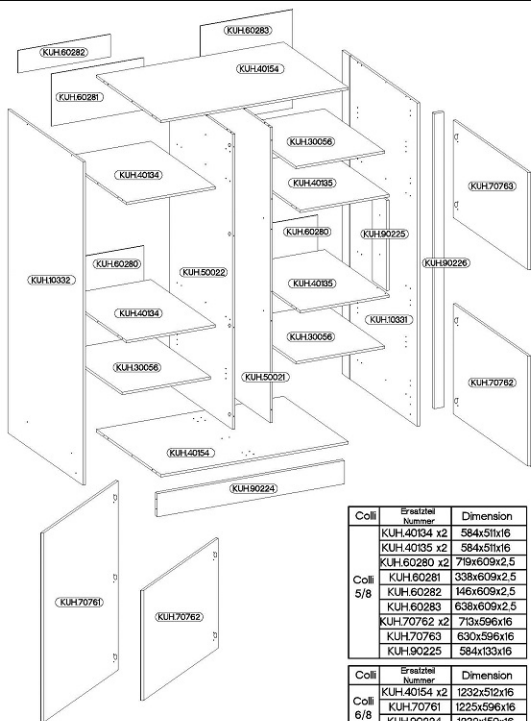

Coll	Ersatzteil Nummer	Dimension
Coll 5/8	KUH.40134 x2	584x511x16
	KUH.40135 x2	584x511x16
	KUH.60280 x2	719x609x2.5
	KUH.60281	338x609x2.5
	KUH.60282	146x609x2.5
	KUH.60283	638x609x2.5
	KUH.70762 x2	713x596x16
	KUH.70763	630x596x16
KUH.90225	584x133x16	

Coll	Ersatzteil Nummer	Dimension
Coll 6/8	KUH.40154 x2	1232x512x16
	KUH.70761	1225x596x16
	KUH.90224	1232x150x16

Coll	Ersatzteil Nummer	Dimension
Coll 8/8	KUH.10331	2095x595x16
	KUH.10332	2095x595x16
	KUH.90226	1911x64x16

Coll	Ersatzteil Nummer	Dimension
Coll 7/8	KUH.30056 x3	583x475x16
	KUH.50021	1912x496x16
	KUH.50022	1912x496x16



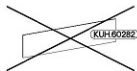
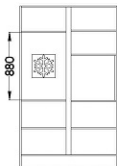
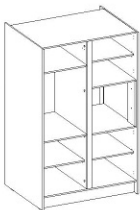
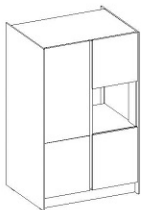

KUH.60282



1 - 22

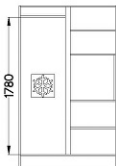
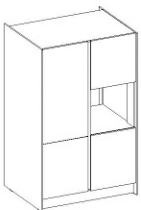

KUH.60281



KUH.30056

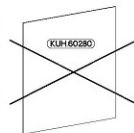

KUH.60280







KUH.40134





23 - 44

1

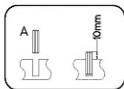
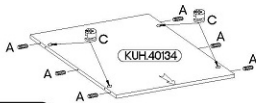
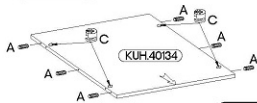
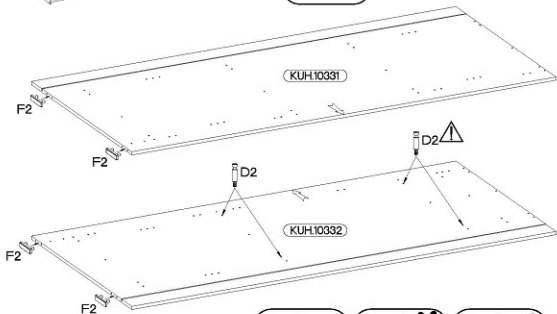
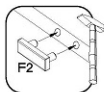
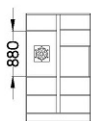
Ø8x30mm	6.5x48x16	Ø5/12mm	L=20mm
			
A	F2	C	D2
12	4	8	4





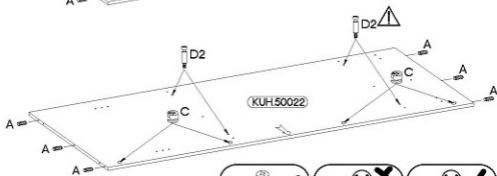
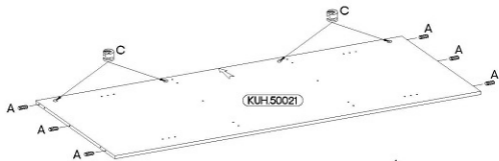
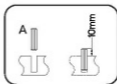

2

ø6x30mm	ø6/12mm	L=20mm
		
A	C	D2
24	8	4



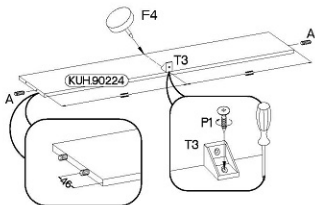
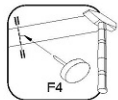
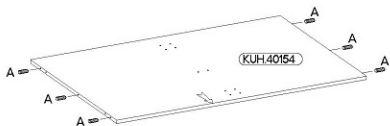
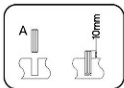

3

16x30mm	L=20mm	115x5mm		4.0x16mm
				
10	8	1	1	1



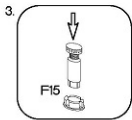
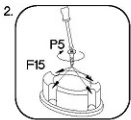
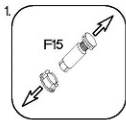
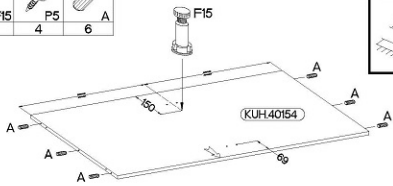

4

L=150mm	43.5x13mm	16x30mm
		
F15	P5	A
1	4	6



5

6,4 x 50mm		
		
B	O	EI
2	1	2

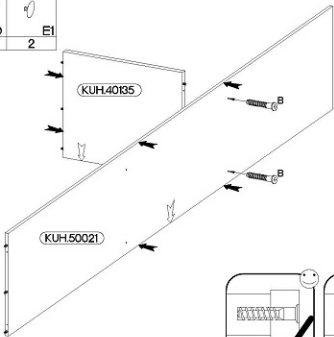

6

6,4 x 50mm

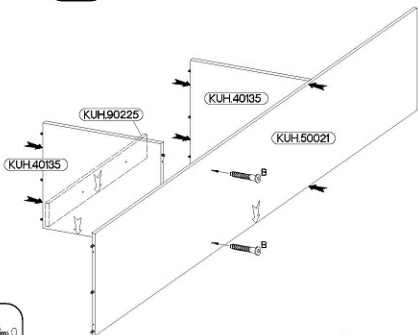
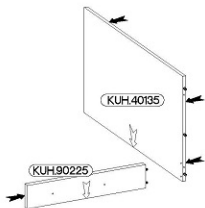
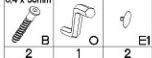

7

6,4 x 50mm

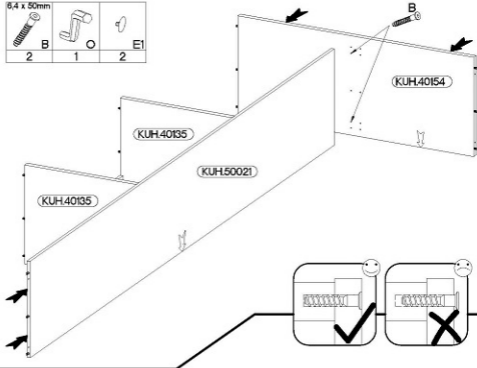
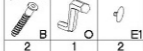

8

6,4 x 50mm

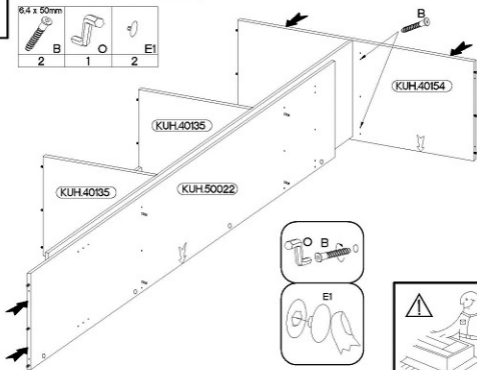
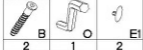

9

6,4 x 50mm



B

O

E1

4

1

4

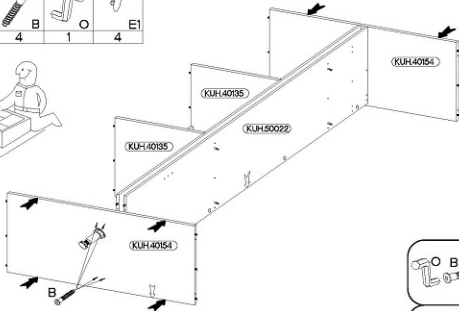

10

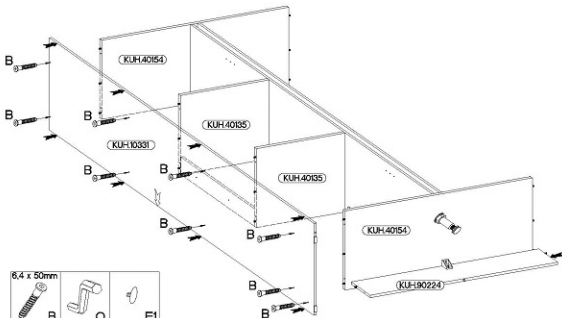

6,4 x 50mm



B

O

E1

9

1

9



11

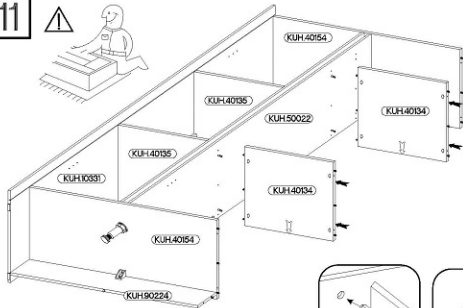

12

6,4 x 50mm



5



1



E1

5

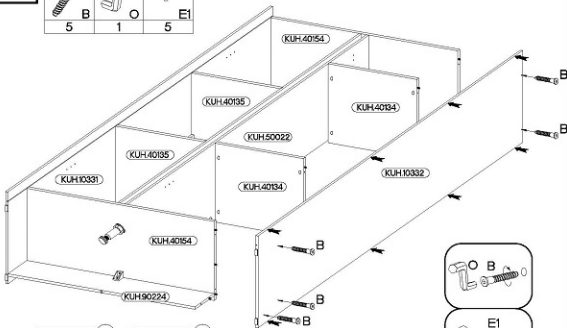

13

+4.0x16mm



1.



2.



3.

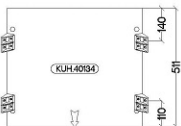
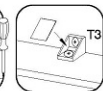
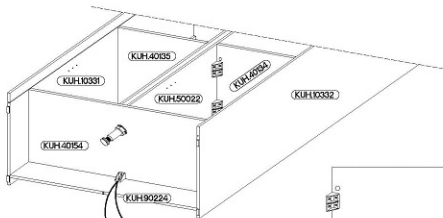

14

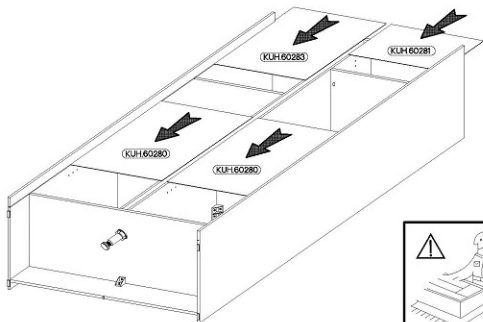

15

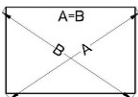

#3.0x20mm

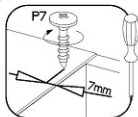
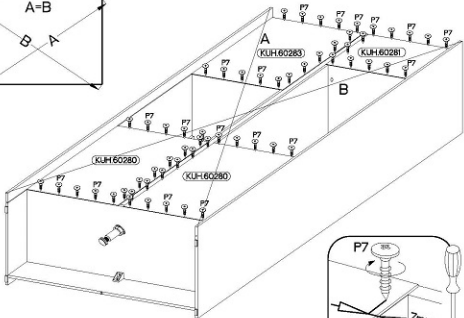

16

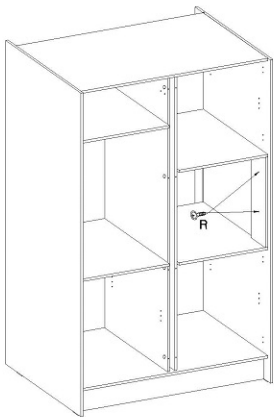

2 Pers.



#4.0x25mm

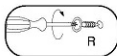

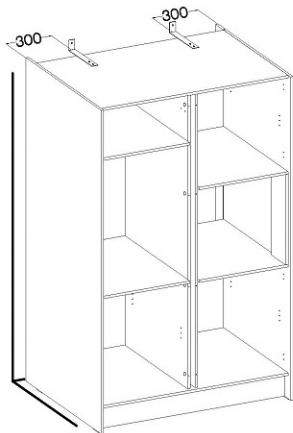
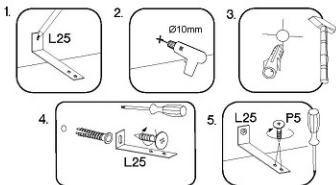
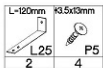

18

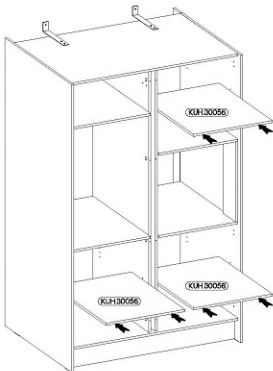

19

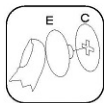
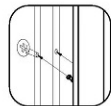
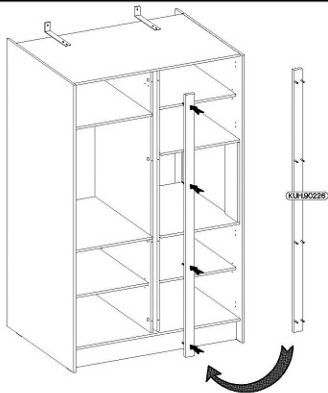

20



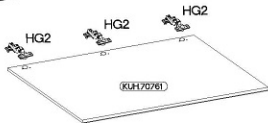
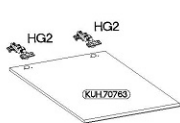
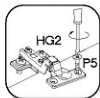
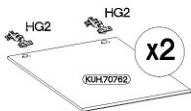

45/16mm	43.5x13mm
	
HG2	P5
9	18

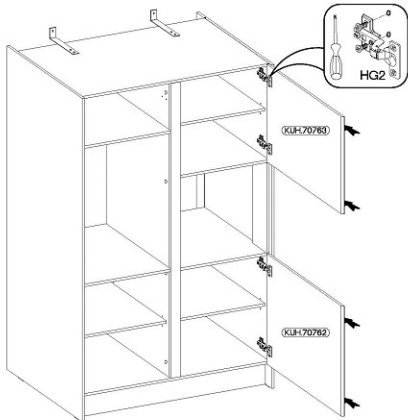

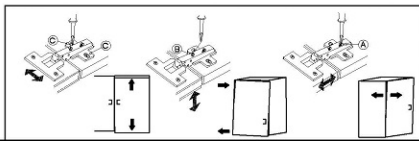
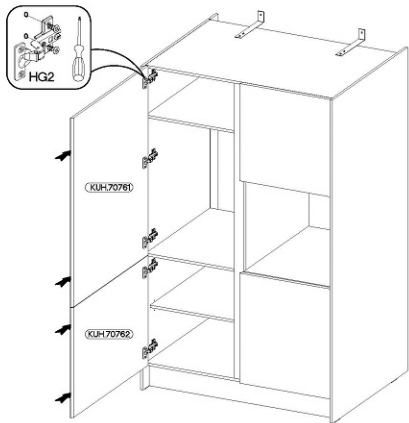
21







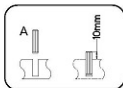
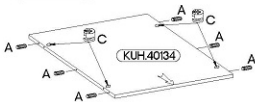
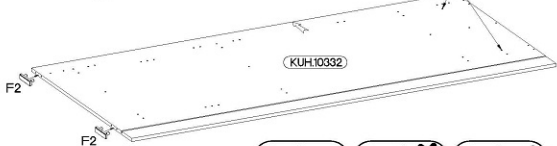
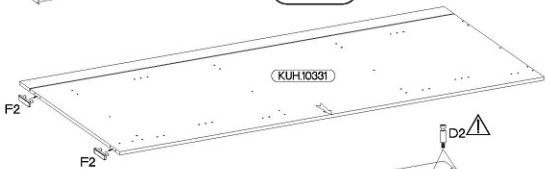
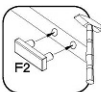
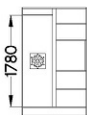
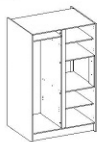





$\varnothing 8 \times 30\text{mm}$  A 6	$6.5 \times 48 \times 16$  F2 4	$\varnothing 5/12\text{mm}$  C 4	$L=20\text{mm}$  D2 2
--	--	---	--

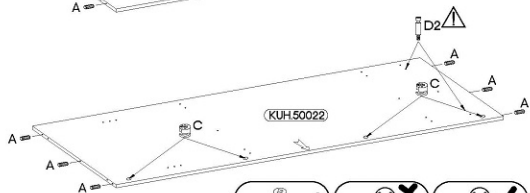
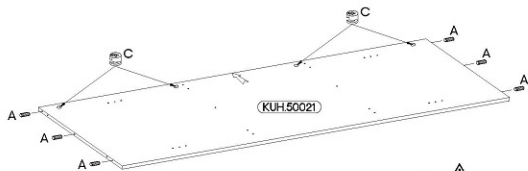
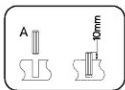







∅6x30mm	∅5/12mm	L=20mm
		
A	C	D2
24	8	2

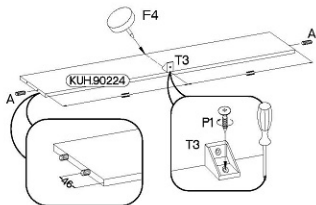
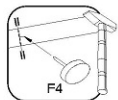
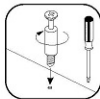
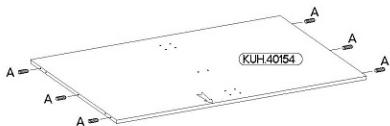
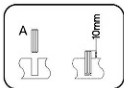

16x30mm	L=20mm	115x5mm		4.0x16mm
				
A	D2	F4	T3	P1
10	8	1	1	1



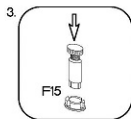
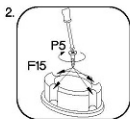
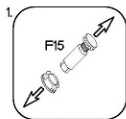
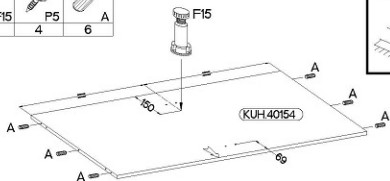

26

L=150mm	43.5x13mm	46x30mm
		
F15	P5	A
1	4	6



27

6,4 x 50mm		
B	O	E1
2	1	2

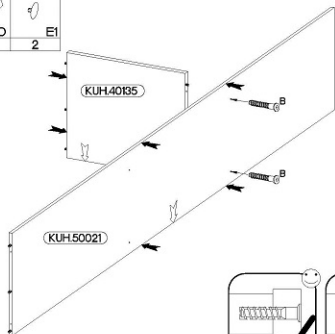

6,4 x 50mm

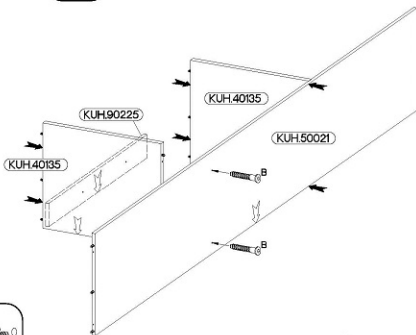
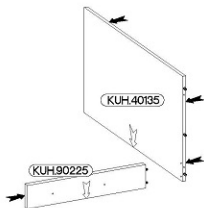

29

6,4 x 50mm

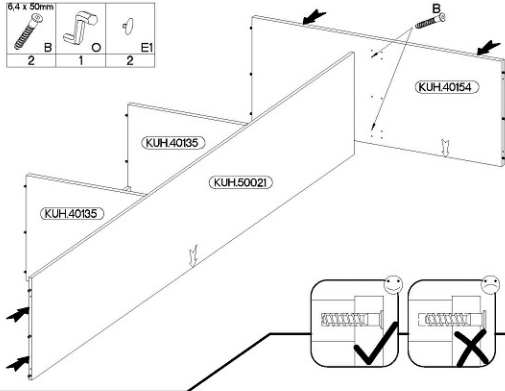
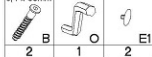

30

6,4 x 50mm

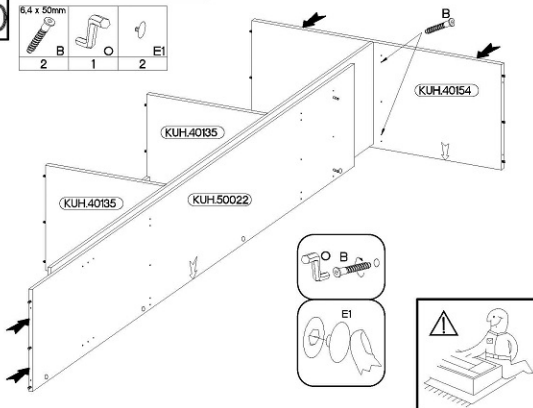

31

6,4 x 50mm



4

1

4

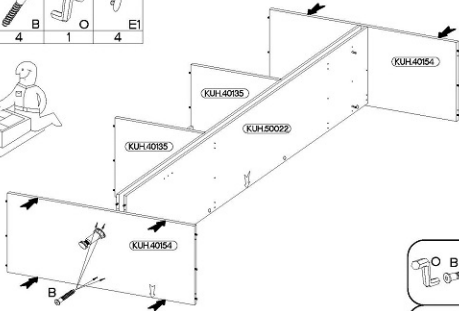

32

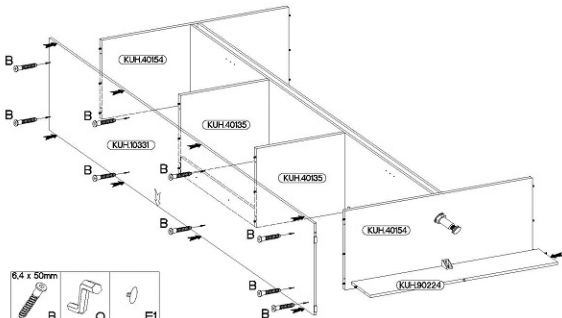

6,4 x 50mm



9

1

9

KUH.40154

KUH.90224

33

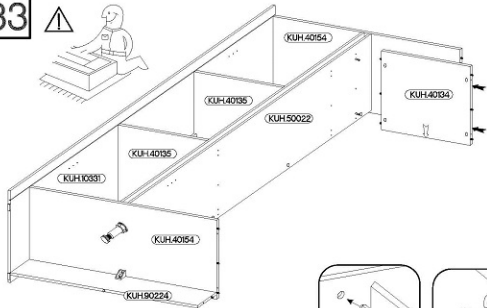

34

6,4 x 50mm



5



1



5

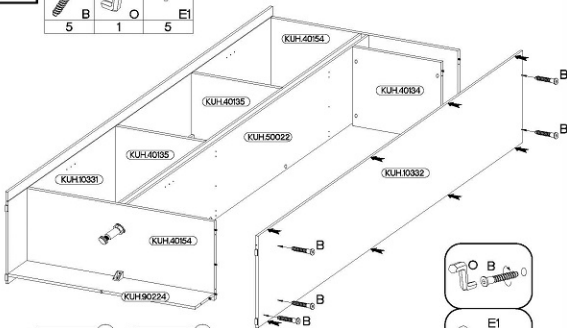

35

+4.0x16mm



P1

1

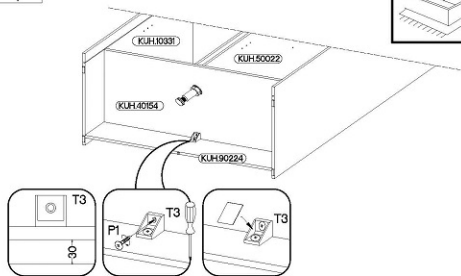

36

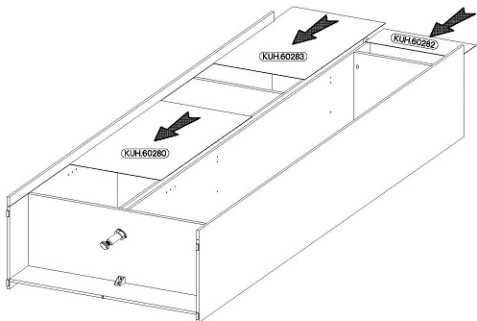



37

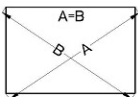

#3.0x20mm

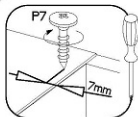
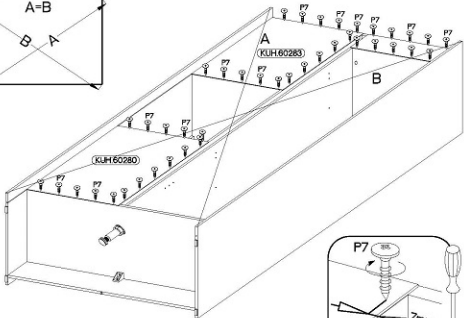

38

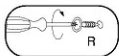
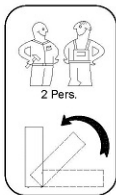
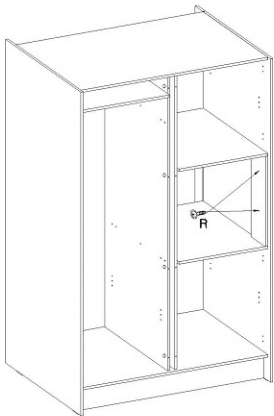

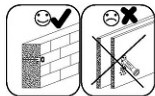
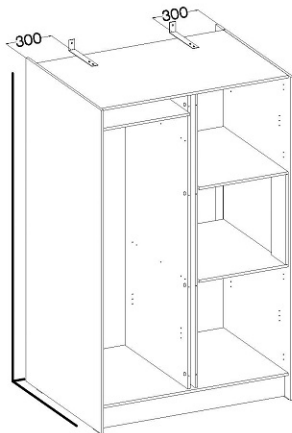
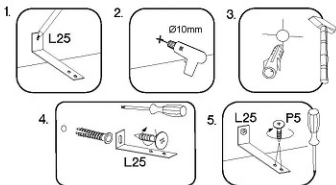
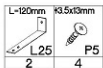

40

#5/16mm



J3

8

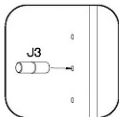
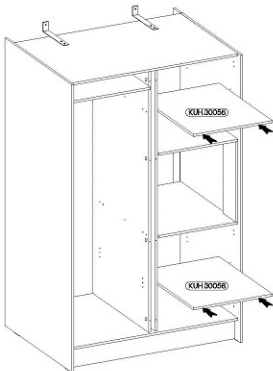

41

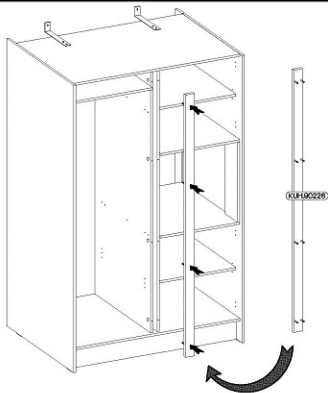



E

12

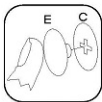
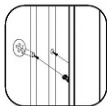
KUH90226



42

 HG2 9	 P5 18
--	---

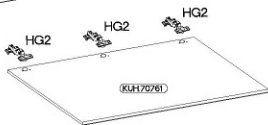
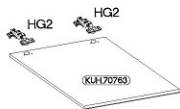
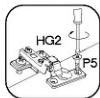
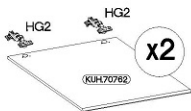

43

