

ИНСТРУКЦИЯ ЗА МОНТАЖ











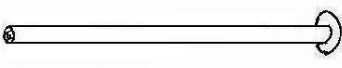
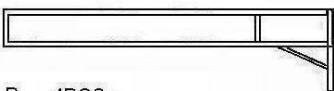
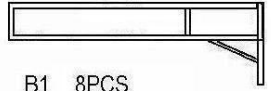
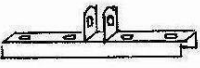
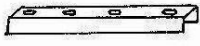

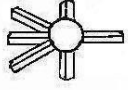
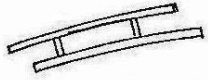

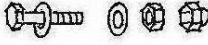
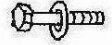
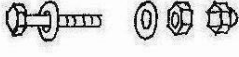

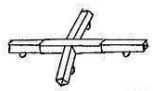
Модел Hawaii 3×6 М

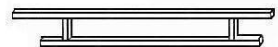
Внимание!

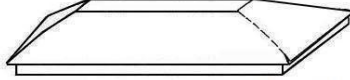
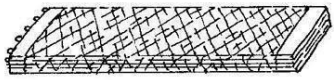
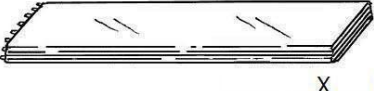
Тази градинска шатра е предназначена да бъде използвана за осигуряване на сянка във Вашата градина, а също и за декоративен елемент в нея. Моля отбележете, че градинската шатра не е конструирана да издържа на екстремни външни условия или на силни и бурни ветрове. При силни ветрове е необходимо да се свалят текстилните елементи от шатрата за да се предотвратят скъсвания на плата, усуквания или счупвания на рамката.

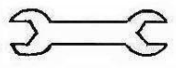
Части в комплекте

 A 4PCS A2 2PCS		 B 4PCS	 B1 8PCS
 C1 2PCS	 C2 10PCS	 D 10 +1PCS	 E 2PCS
 F 4PCS	 G 4PCS	 H1 6x12 12PCS	 H2 6x25 24PCS
 H3 6x32 60+2 PCS	 I 2PCS	 J 6PCS	
 K 1PC	 M 1PC	 N 1PC	
 U 1PC	 V 1PC	 W 1PC	
 X 1PC	 O 132 +4 PCS	 Y 12 PCS	 Z 2PCS
 12 PCS			

Монтажная схема

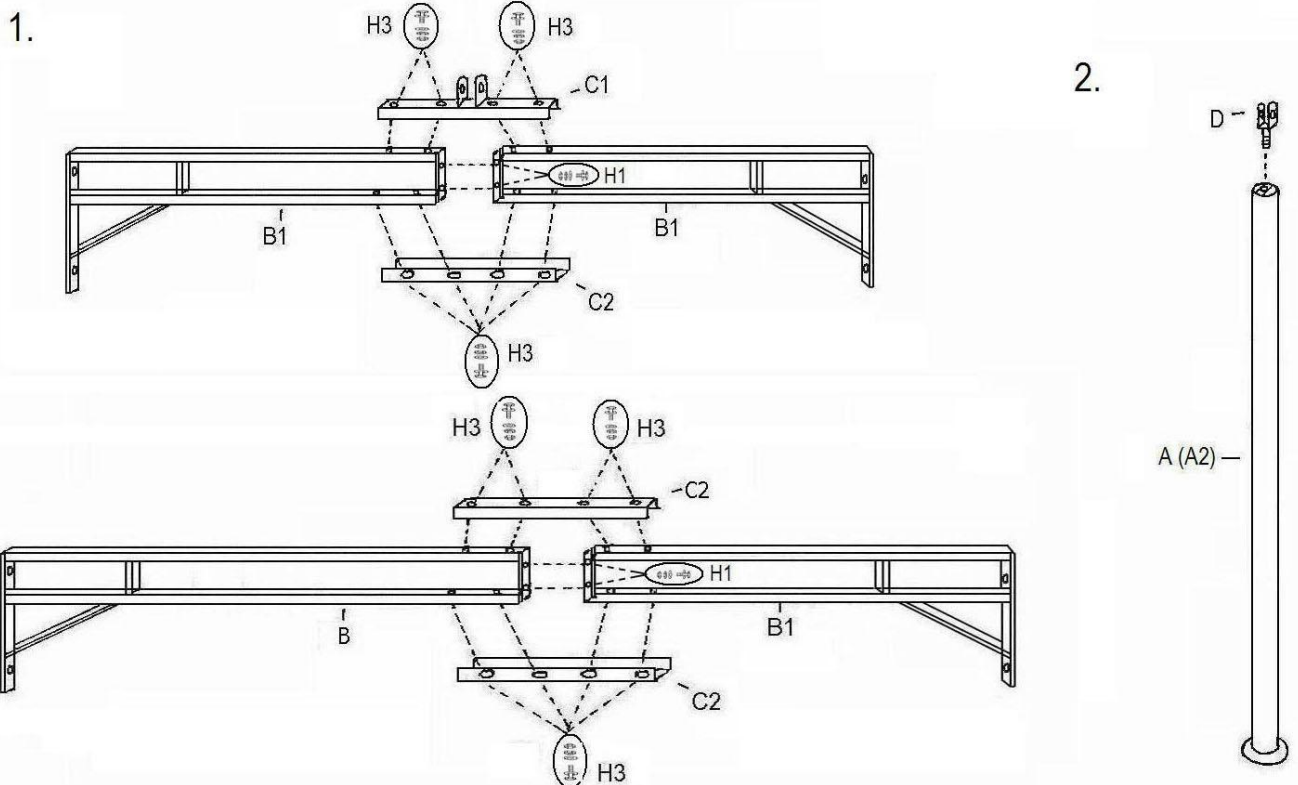

3.

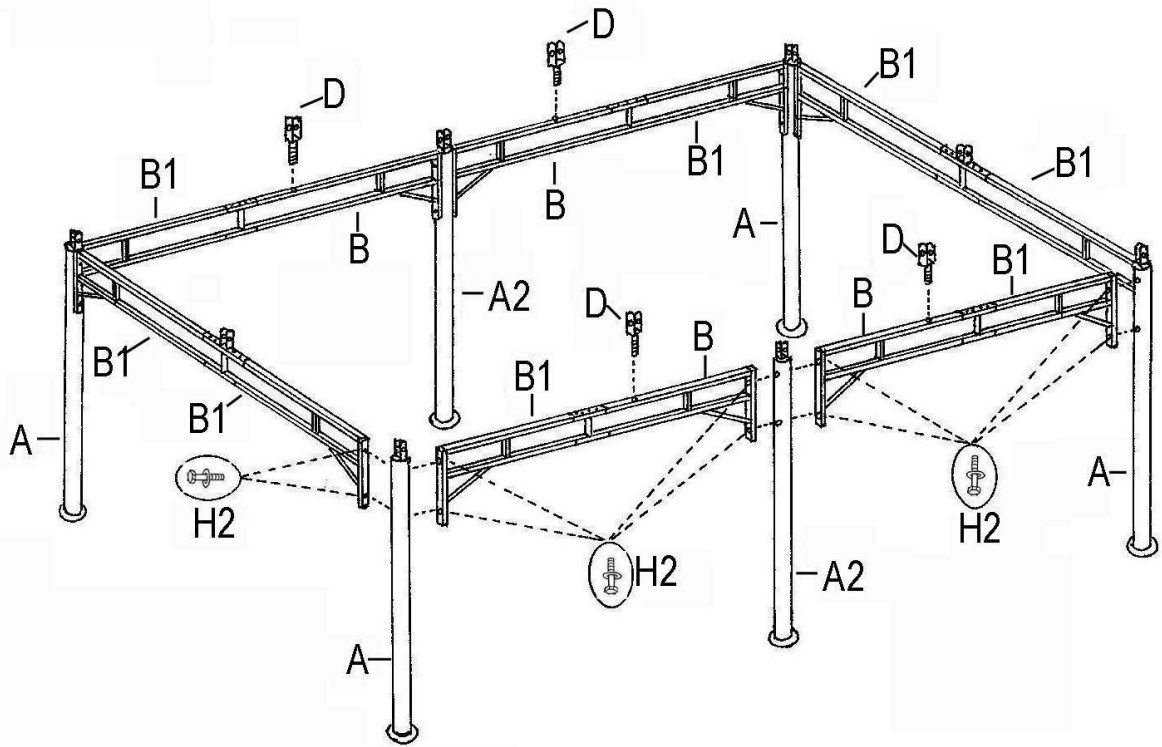

4.

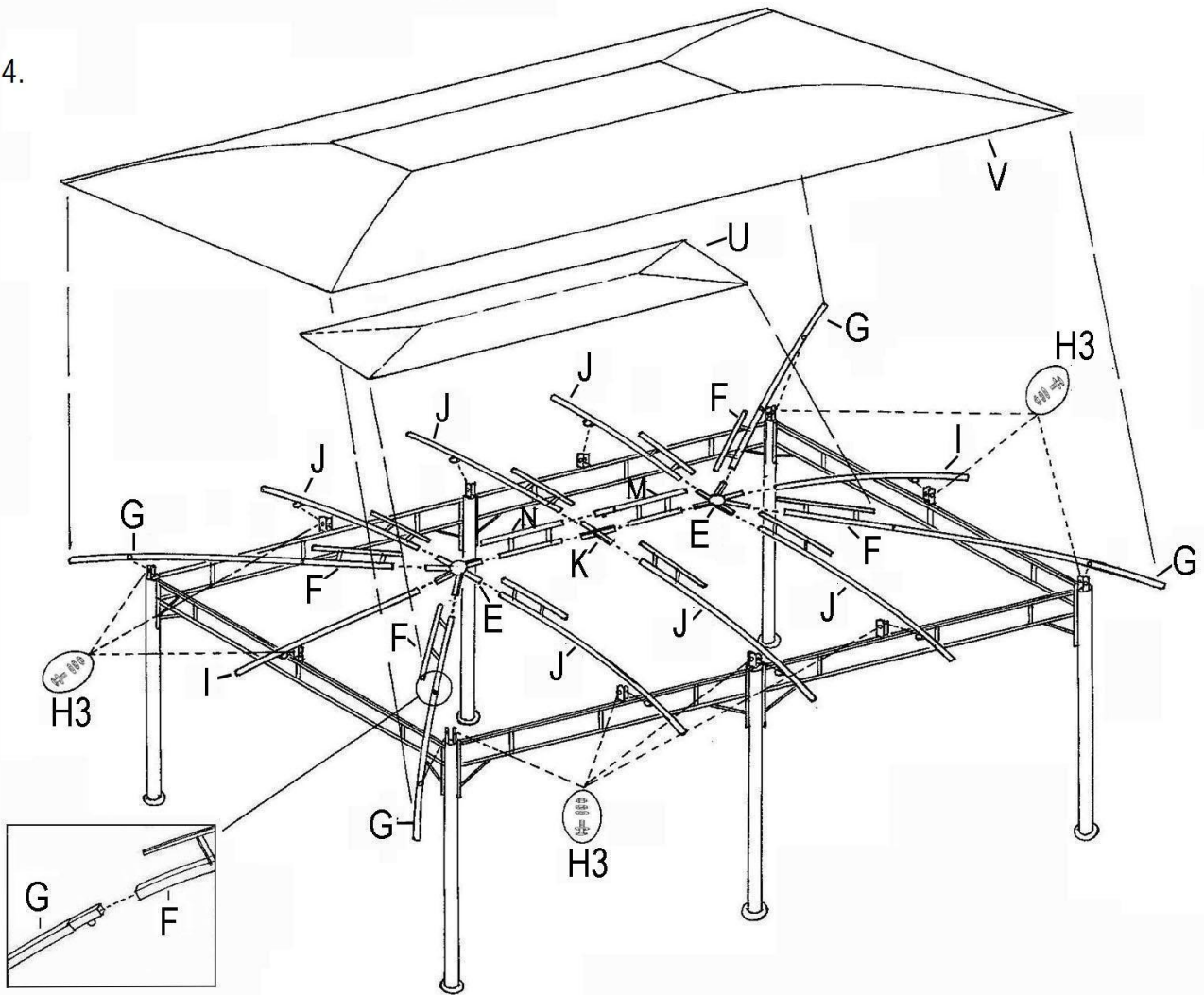

Поставяне на текстилния покрив: Важно е първо да опънете и фиксирате текстилния покрив към металната конструкция в ъглите. След това опънете и фиксирате текстилния покрив в средата.

5.

